

## Mounting Expand M2

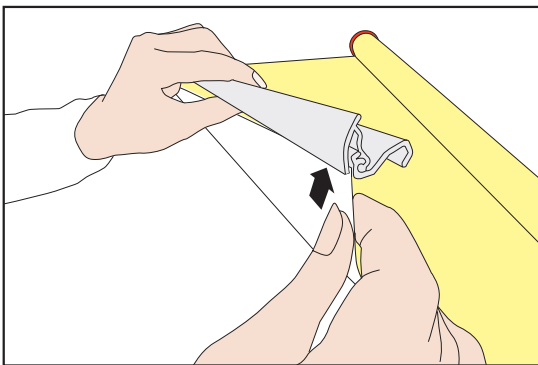

1. **IMPORTANT!** Media roll should be tightly wound.
2. Connect left side of media roll to the red knob.
3. Lower right side of media roll to let metal pin slide into locking slot.
4. Lock media tube by pushing the metal tab inwards.
5. Close the front section.

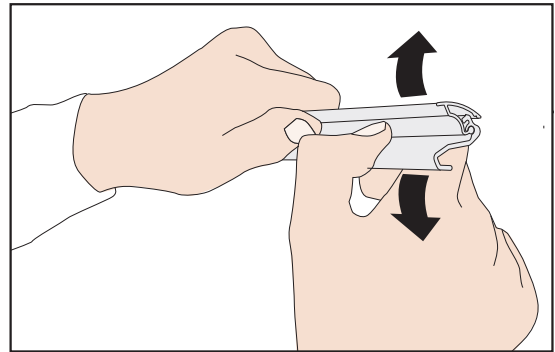
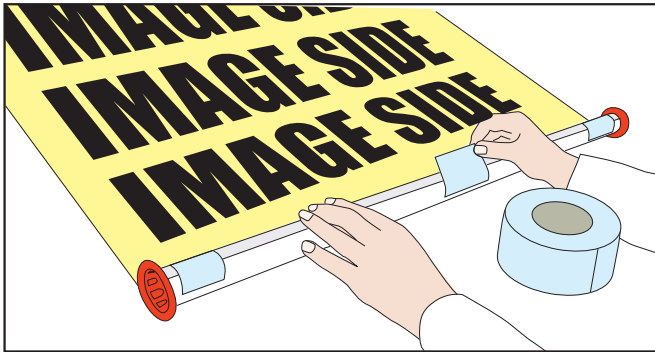
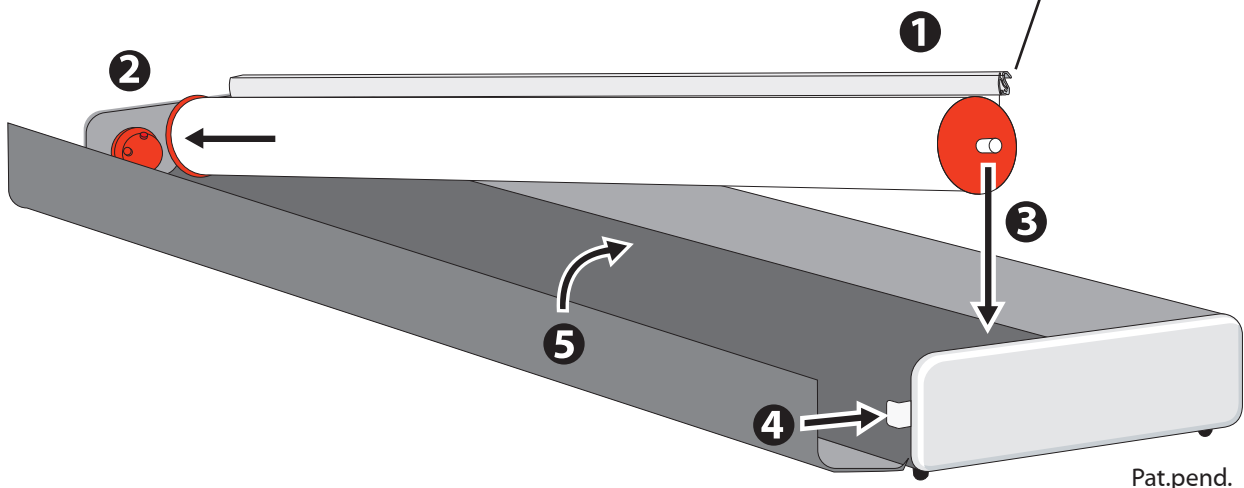
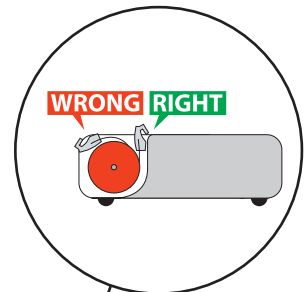

# Expand M2

## Set up instructions

### Set up - Step by step

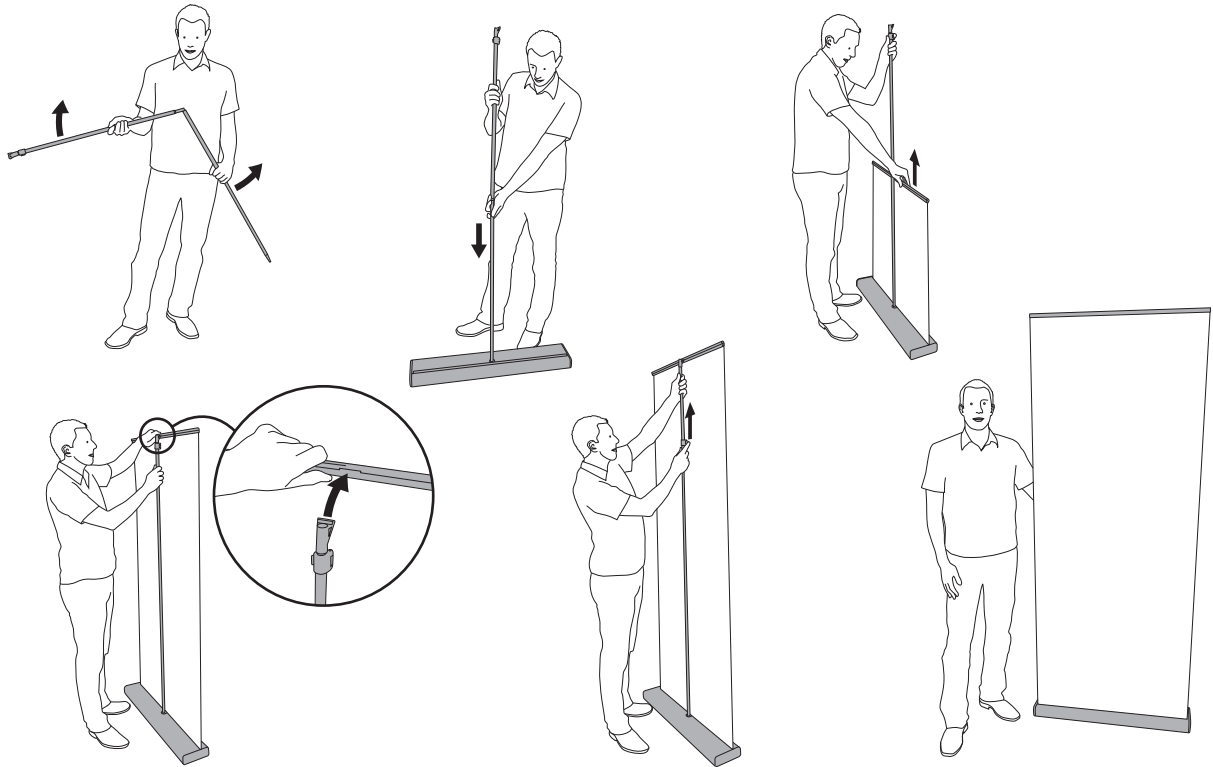

### How to switch media roll

Pat.pend.

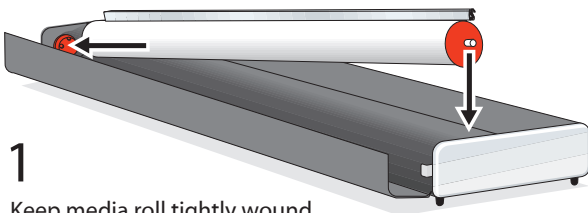

1

- Keep media roll tightly wound
- The top profile should be in the position pictured below
- Place hollow end of media roll on to left side connector knob
- Then place the right side of the media roll with the metal pin into the locking slot

**RIGHT**

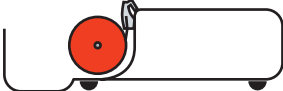

**WRONG**

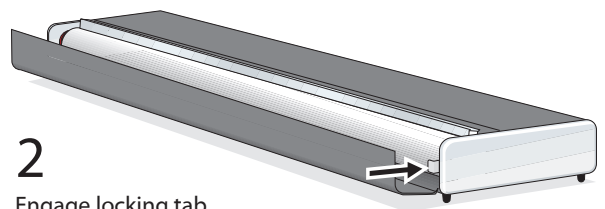
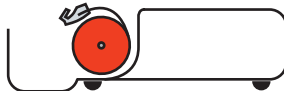

2

- Engage locking tab by pushing it inwards.

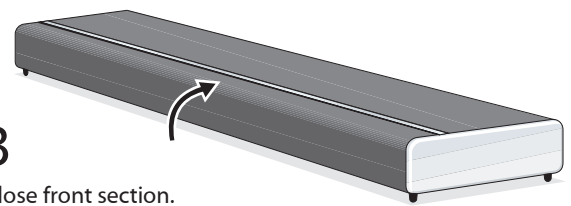

3

- Close front section.

**expand**<sup>®</sup>

expandmedia.com